

DYNAMIC FILTRATION INC

EDM FILTERS

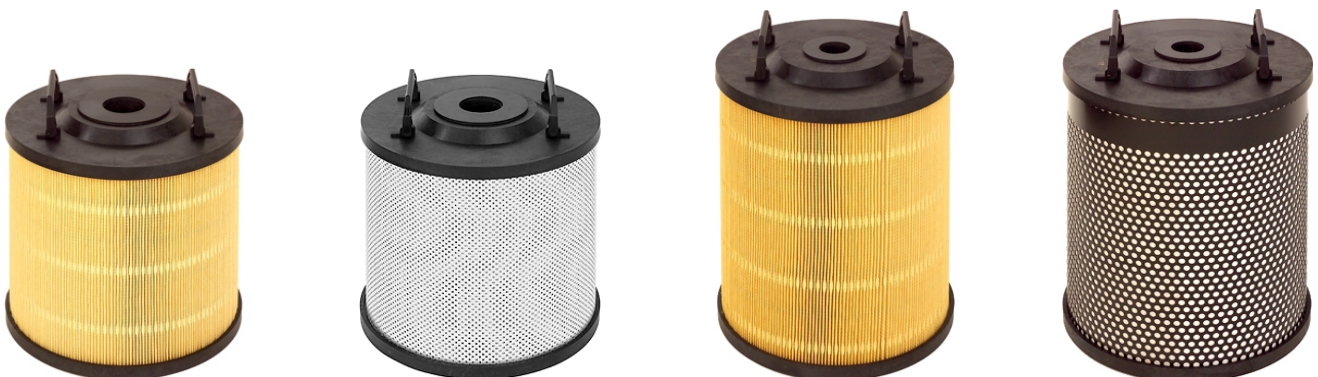

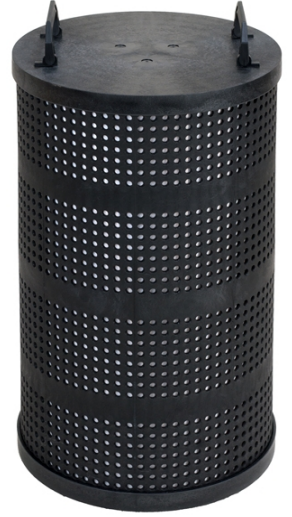
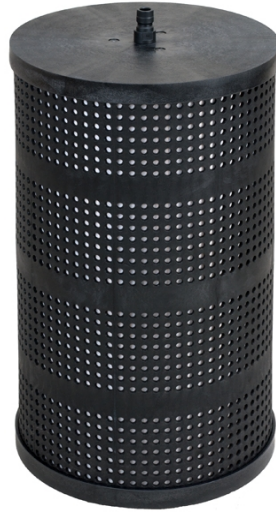

**ACCUTEX
WIRE
MACHINES**

DYNAMIC FILTRATION

ALL ACCUTEX WIRE

- AX Series
- SP Series
- AU Series

TOP



BOTTOM



PART # 5 MICRON	PART # 10 MICRON	QUICK CONNECT	OD	HEIGHT	
1220-5QCA	1220-10QCA	COUPLER	12" (305 MM)	19 5/8" (498 MM)	

**ACCUTEX
SINKER
MACHINES**

DS 5040 SINKER

TOP



BOTTOM



PART # 3 MICRON	PART # 5 MICRON	PART # 10 MICRON	QUICK CONNECT	OD	HEIGHT
1312-3QCM	1312-5QCM	1312-10QCM	COUPLER	13 1/4" (337MM)	12" (305 MM)

**AGIE
WIRE
MACHINES**

DYNAMIC FILTRATION

ALL AGIE WIRE

VERTEX
EXCELLENCE
CHALLENGE
PROGRESS
CLASSIC



DF100
DF200
614-125-GH
614-125-GHW
614-125-GHWP

PART # 3 MICRON	PART # 5 MICRON	PART # 10 MICRON	PART # 20 MICRON	ID	OD	HEIGHT
DF100				32 MM	6" (152 MM)	14 3/4" (375 MM)
DF200				32 MM	6" (152 MM)	14 1/4" (362 MM)
	614-125-GH5	614-125-GH10	614-125-GH20	32 MM	6" (152 MM)	14 1/2" (368 MM)
	614-125-GHW5	614-125-GHW10	614-125-GHW20	32 MM	6" (152 MM)	14 1/2" (368 MM)
	614-125-GHWP5			32 MM	6" (152 MM)	14 1/2" (368 MM)



PART # 3 MICRON	PART # 20 MICRON	ID	OD	HEIGHT	
DF400	DF400-20	32 MM	6" (152 MM)	28 3/4" (730 MM)	

**AGIE
SINKER
MACHINES**

DYNAMIC FILTRATION

ALL AGIE SINKERS
MONDO
HYPER SPARK EXACT
HYPER SPARK
ADVANCE
SPIRIT



PART # 3 MICRON	PART # 5 MICRON	PART # 10 MICRON	PART # 20 MICRON	ID	OD	HEIGHT
DF100				32 MM	6" (152 MM)	14 3/4" (375 MM)
DF200				32 MM	6" (152 MM)	14 1/4" (362 MM)
	614-125-GH5	614-125-GH10	614-125-GH20	32 MM	6" (152 MM)	14 1/2" (368 MM)
	614-125-GHW5	614-125-GHW10	614-125-GHW20	32 MM	6" (152 MM)	14 1/2" (368 MM)
	614-125-GHWP5			32 MM	6" (152 MM)	14 1/2" (368 MM)
		CH56P		32 MM	6" (152 MM)	14 1/2" (368 MM)

**BROTHER
WIRE
MACHINES**

DYNAMIC FILTRATION

ALL BROTHER WIRE
ALL "H" SERIES

- HS100
- HS300
- HS3000
- HS3100
- HS3100AWT
- HS350
- HS3600
- HS3600AWT
- HS50A-AWT
- HS50A-STD
- HS5100
- HS5100AWT
- HS70A

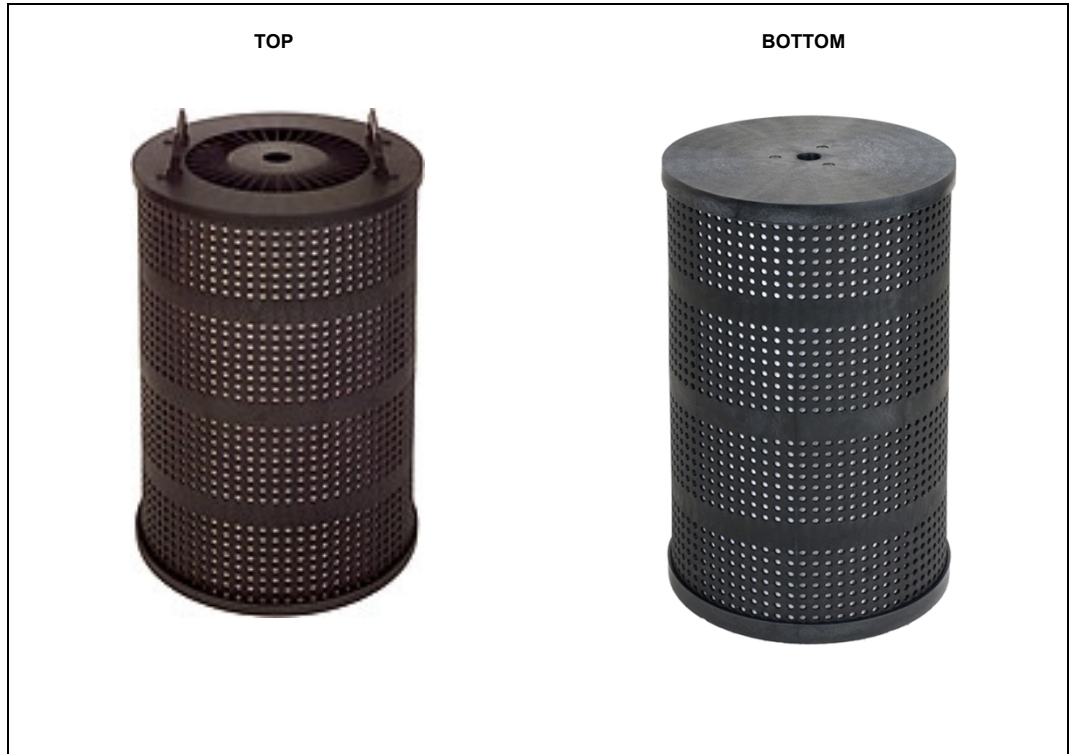

PART # 3 MICRON	PART # 5 MICRON	ID	OD	HEIGHT
1220-3	1220-5	1 3/16" (30 MM)	12" (305 MM)	19 5/8" (498 MM)

**CHARMILLES
WIRE
MACHINES**

DYNAMIC FILTRATION

ROBOFIL	
100	310F
1500	310P
200	330F
290	400
290AWT	4000
290F	510
290P	510F
290PAWT	510P
2000	600
300	6000
310	
1020 SERIES	4020 SERIES
2020 SERIES	4030 SERIES
2030 SERIES	6020 SERIES
2040 SERIES	6030 SERIES



PART # 3 MICRON	PART # 5 MICRON	PART # 10 MICRON	PART # 20 MICRON	ID	OD	HEIGHT
DF100				32 MM	6" (152 MM)	14 3/4" (375 MM)
DF200				32 MM	6" (152 MM)	14 1/4" (362 MM)
	614-125-GH5	614-125-GH10	614-125-GH20	32 MM	6" (152 MM)	14 1/2" (368 MM)
	614-125-GHW5	614-125-GHW10	614-125-GHW20	32 MM	6" (152 MM)	14 1/2" (368 MM)
	614-125-GHWP5			32 MM	6" (152 MM)	14 1/2" (368 MM)

ROBOFIL	
2000	
4000	
6000	
1020 SERIES	4020 SERIES
2020 SERIES	4030 SERIES
2030 SERIES	6020 SERIES
2040 SERIES	6030 SERIES



PART # 3 MICRON	PART # 20 MICRON	ID	OD	HEIGHT
DF400	DF400-20	32 MM	6" (152 MM)	28 3/4" (730 MM)



**CHARMILLES
WIRE
MACHINES**

DYNAMIC FILTRATION

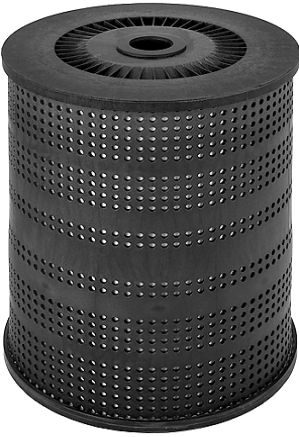
ROBOFIL	
230	390
240	690
240CC	F1230
440	
440CC	
ALL MODELS BEFORE DEC. 2004	

TOP		BOTTOM		
				
PART #	PART #	ID	OD	HEIGHT
3 MICRON	5 MICRON			
1318-B3C	1318-B5C	1 7/8" (48 MM)	13 1/4" (337 MM)	17" (432 MM)

ROBOFIL	
	FI640
240SL	640
440SL	640CC
ALL MODELS AFTER DEC. 2004	
240CC	2050 TW
440CC	6050 TW
CUT 200	
20P	
30P	

TOP		BOTTOM		
				
PART #	PART #	QUICK CONNECT	OD	HEIGHT
3 MICRON	5 MICRON			
1316-3QCG	1316-5QCG	3/4" BPT	13 1/4" (337 MM)	16 7/8" (429 MM)

ROBOFIL

240SL FI640
 440SL 640
 640CC

ALL MODELS AFTER DEC. 2004

240CC 2050 TW
 440CC 6050 TW
 CUT 200
 20P
 30P

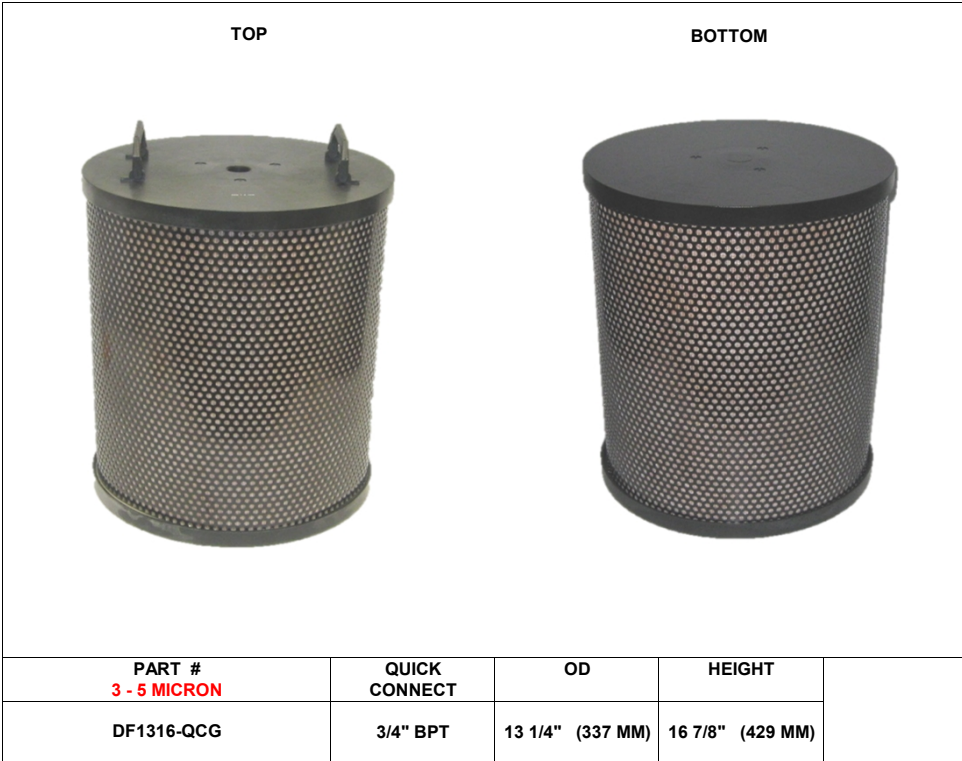

PART #	QUICK CONNECT	OD	HEIGHT
3 - 5 MICRON			
DF1316-QCG	3/4" BPT	13 1/4" (337 MM)	16 7/8" (429 MM)

**CHARMILLES
SINKER
MACHINES**

DYNAMIC FILTRATION

ROBOFORM	ACTSPARK
FM20	SD1
FM20A	SE1-50
FM20CNC	SE2-50
FM20ZNC	SP1-50
FO100	SP3-100
FO20	35P
FO200	54P
FO2000	55P
FO2000L	20ZNC
FO2000QCR	
FO20A	
FO22	
FO23	
FO2400	
FO2400L	
FO30	FOR ALL SINKERS
FO31	
FO31BA	
FO35	
FO350	
FO35P	
FO40	
FO400	
FO4000	
FO4000DT	
FO4000L	
FO41	
FO44	
FO50	
FO51	
FO54	
FO54P	
FO55	
FO550	
FO55P	
FO810	
FO84	
FO85	

						
<p style="text-align: center;"> DF100 DF200 614-125-GH 614-125-GHW 614-125-GHWP CH56P </p>						
PART #	PART #	PART #	PART #	ID	OD	HEIGHT
3 MICRON	5 MICRON	10 MICRON	20 MICRON			
DF100				32 MM	6" (152 MM)	14 3/4" (375 MM)
DF200				32 MM	6" (152 MM)	14 1/4" (362 MM)
	614-125-GH5	614-125-GH10	614-125-GH20	32 MM	6" (152 MM)	14 1/2" (368 MM)
	614-125-GHW5	614-125-GHW10	614-125-GHW20	32 MM	6" (152 MM)	14 1/2" (368 MM)
	614-125-GHWP5			32 MM	6" (152 MM)	14 1/2" (368 MM)
		CH56P		32 MM	6" (152 MM)	14 1/2" (368 MM)

**CHMER
WIRE
MACHINES**

DYNAMIC FILTRATION

AH 64C

TOP



BOTTOM



PART # 3 MICRON	PART # 5 MICRON	PART # 10 MICRON	QUICK CONNECT	OD	HEIGHT
1312-3QC	1312-5QC	1312-10QC	COUPLER	13 1/4" (337 MM)	12" (305 MM)

AU 22SL
AU 35L

TOP



BOTTOM



PART # 5 MICRON	PART # 10 MICRON	QUICK CONNECT	OD	HEIGHT	
1220-5QCA	1220-10QCA	COUPLER	12" (305 MM)	19 5/8" (498 MM)	

**EBBCO
FILTER
SYSTEM**

DYNAMIC FILTRATION

ALL EBBCO "HR" SERIES



PART # 3 MICRON	PART # 5 MICRON	PART # 10 MICRON	PART # 20 MICRON	ID - TOP	ID - BOTTOM	OD	HEIGHT
DF700-3	DF700-5	DF700-10	DF700-20	3" NPT	2 5/8" (67 MM)	7 3/4" (178 MM)	29 1/8" (740 MM)

ALL EBBCO "SC" SERIES

PART # 5 MICRON	ID - TOP	ID - BOTTOM	OD	HEIGHT
DF700-SC5	3" NPT	CLOSED	7 3/4" (178 MM)	29 1/8" (740 MM)

**ELOX
WIRE
MACHINES**

DYNAMIC FILTRATION

OLD ELOX MODELS



PART # 5 MICRON	ID	OD	HEIGHT
1318-B5	1 7/8" (48 MM)	13 1/4" (337 MM)	18" (457 MM)

**ELOX
SINKER
MACHINES**

ELOX ELTEE



718-262-BH

718-262-BHW

PART # 5 MICRON	PART # 10 MICRON	PART # 20 MICRON	ID	OD	HEIGHT
718-262-BH5	718-262-BH10	718-262-BH20	2 5/8" (67 MM)	6" (152 MM)	18" (457 MM)
718-262-BW5	718-262-BW10	718-262-BW20	2 5/8" (67 MM)	6" (152 MM)	18" (457 MM)
718-262-BHW5	718-262-BHW10	718-262-BHW20	2 5/8" (67 MM)	6" (152 MM)	18" (457 MM)

FANUC
MACHINES

DYNAMIC FILTRATION

O SERIES
P SERIES
Q SERIES
R SERIES
S SERIES
T SERIES
V SERIES

TOP



BOTTOM

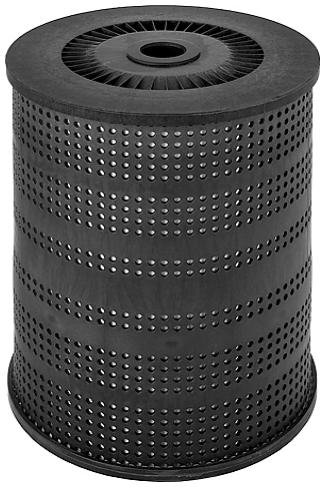

PART #	ID	OD	HEIGHT
5 MICRON			
1318-B5F	1 7/8" (48 MM)	13 1/4" (337 MM)	17" (432 MM)

FANUC
MACHINES

IB SERIES
IE SERIES
OIC SERIES
OID SERIES

QC500
QC600
QC800

TOP



BOTTOM



PART #	PART #	PART #	QUICK CONNECT	OD	HEIGHT
3 MICRON	5 MICRON	10 MICRON			
1312-3QCLF	1312-5QCLF	1312-10QCLF	COUPLER	13 1/4" (337 MM)	12" (305 MM)

DYNAMIC FILTRATION

FANUC MACHINES

IB SERIES
IE SERIES
OIC SERIES
OID SERIES

QC500
QC600
QC800

MITSUBISHI WIRE MACHINES

FA10 SERIES
FA20 SERIES
FA30 SERIES
FA10 ADVANCE SERIES
FA20 ADVANCE SERIES
FA30 ADVANCE SERIES
NA1200 ADVANCE
MD PRO
MD PRO II
BA 24
MV SERIES
NA SERIES
MD1200R

MAKINO WIRE MACHINES

SP53 SERIES
SP64 SERIES
SP43 SERIES
EU SERIES
DUO43
DUO64
ECQ53

TOP



BOTTOM



FANUC

COUPLERS IN CARTON

MITSUBISHI
MAKINO

PART #	QUICK CONNECT	OD	HEIGHT
3-5 MICRON			
DF1312-FM KIT	COUPLER	13 1/4" (337 MM)	12" (305 MM)

FANUC MACHINES

QC500
QC600
QC800





PART #	QUICK CONNECT	OD	HEIGHT
3 MICRON			
1318-3QCLF	COUPLER	13 1/4" (337 MM)	18" (457 MM)



HITACHI
WIRE
MACHINES

DYNAMIC FILTRATION

H-CUT

TOP		BOTTOM	
			
PART #	ID	OD	HEIGHT
5 MICRON			
1214-B5	1 3/4" (44 MM)	12" (305 MM)	13 1/2" (343 MM)

SERIES
F
R

TOP		BOTTOM	
			
PART #	QUICK CONNECT	OD	HEIGHT
5 MICRON			
1312-5QCH	COUPLER	13 1/4" (337 MM)	12" (305 MM)

**JAPAX
WIRE
MACHINES**

DYNAMIC FILTRATION

ALL WIRE MACHINES

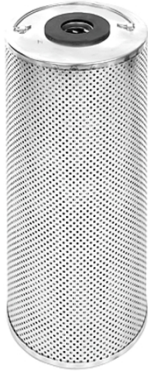



614-125-BH
614-125-BHW

PART # 5 MICRON	PART # 10 MICRON	PART # 20 MICRON	ID	OD	HEIGHT
614-125-BH5	614-125-BH10	614-125-BH20	1 1/4" (32 MM)	6" (152 MM)	14" (356 MM)
614-125-BHW5	614-125-BHW10	614-125-BHW20	1 1/4" (32 MM)	6" (152 MM)	14" (356 MM)

**JAPAX
SINKER
MACHINES**

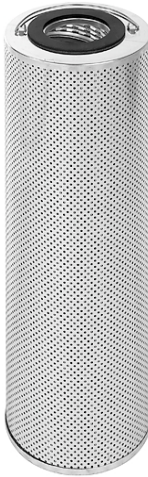
DF125
DP200
DXC25
DXC30
DXC45
JX2
JX3
JX3R
JX4
JX4R
800LS
LS800X



718-262-BH
718-262-BHW

PART # 5 MICRON	PART # 10 MICRON	PART # 20 MICRON	ID	OD	HEIGHT
718-262-BH5	718-262-BH10	718-262-BH20	2 5/8" (67 MM)	6" (152 MM)	18" (457 MM)
718-262-BW5	718-262-BW10	718-262-BW20	2 5/8" (67 MM)	6" (152 MM)	18" (457 MM)
718-262-BHW5	718-262-BHW10	718-262-BHW20	2 5/8" (67 MM)	6" (152 MM)	18" (457 MM)

**MAKINO
WIRE
MACHINES**

DYNAMIC FILTRATION

SP53 SERIES
SP64 SERIES
SP43 SERIES
EU SERIES
DUO43
DUO64
ECQ53





TOP			BOTTOM		
					
PART # 3 MICRON	PART # 5 MICRON	PART # 10 MICRON	QUICK CONNECT	OD	HEIGHT
1312-3QCM	1312-5QCM	1312-10QCM	COUPLER	13 1/4" (337 MM)	12" (305 MM)

**MAKINO
WIRE
MACHINES**

SP53 SERIES
SP64 SERIES
SP43 SERIES
EU SERIES
DUO43
DUO64
ECQ53

**MITSUBISHI
WIRE
MACHINES**

FA10 SERIES
FA20 SERIES
FA30 SERIES
FA10 ADVANCE SERIES
FA20 ADVANCE SERIES
FA30 ADVANCE SERIES
NA1200 ADVANCE
MD PRO
MD PRO II
BA 24
MV SERIES
NA SERIES
MD1200R

TOP		BOTTOM	
			
	COUPLERS IN CARTON		
FANUC		MITSI MAKINO	
PART # 3-5 MICRON		QUICK CONNECT	OD
DF1312-FM KIT		COUPLER	13 1/4" (337 MM)
			HEIGHT
			12" (305 MM)

**FANUC
MACHINES**

IB SERIES
IE SERIES
OIC SERIES
OID SERIES

QC500
QC600
QC800

**MAKINO
SINKER
MACHINES**

EDAF-2
EDAF-3



PART # 5 MICRON	PART # 10 MICRON	ID	OD	HEIGHT
1016-BH5	1016-BH10	1 3/4" (44 MM)	10 1/4" (260 MM)	16" (406 MM)

**MAKINO
SINKER
MACHINES**

EC3025 SERIES
EC3040 SERIES
EC7050 SERIES
EDF2629 SERIES
EDNC SERIES
EDGE SERIES

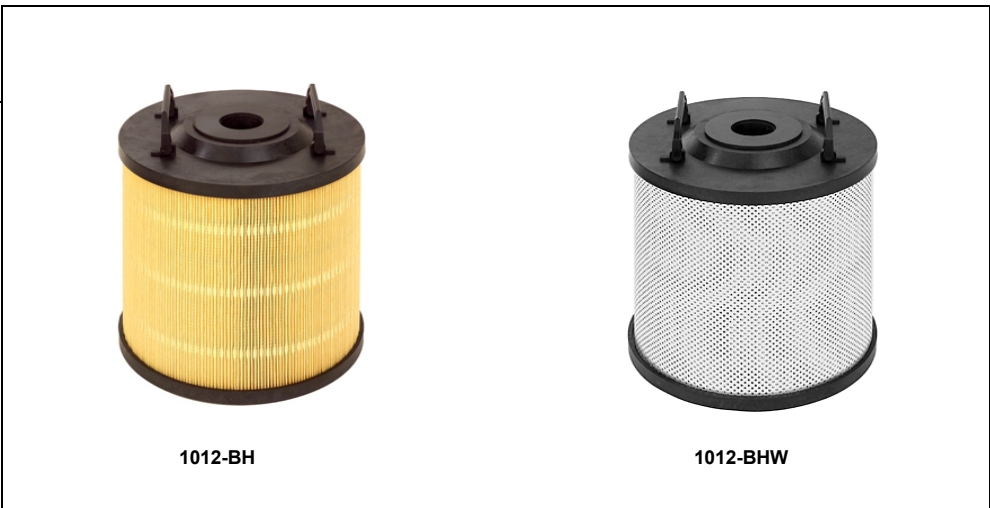

PART # 5 MICRON	PART # 10 MICRON	PART # 20 MICRON	ID	OD	HEIGHT
1012-BH5	1012-BH10	1012-BH20	1 3/4" (44 MM)	10 1/4" (260 MM)	11 3/8" (289 MM)
1012-BHW5			1 3/4" (44 MM)	10 1/4" (260 MM)	11 3/8" (289 MM)

**MITSUBISHI
WIRE
MACHINES**

DYNAMIC FILTRATION

DWC70
DWC90
F SERIES
G SERIES
H SERIES
C SERIES



PART #	PART #	ID	OD	HEIGHT
3 MICRON	5 MICRON			
1220-3	1220-5	1 3/16" (30 MM)	12" (305 MM)	19 5/8" (498 MM)
1220-X3	1220-X5	1 3/16" (30 MM)	12" (305 MM)	19 5/8" (498 MM)

LONGER SERVICE LIFE >>>>

SX

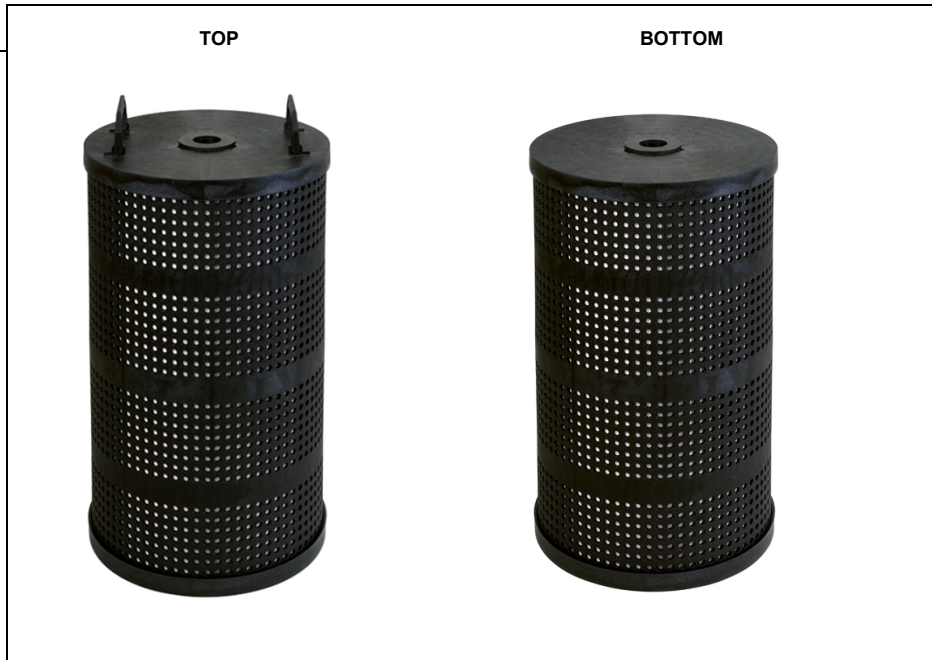

PART #	PART #	ID	OD	HEIGHT
3 MICRON	5 MICRON			
1220-B3	1220-B5	1 3/16" (30 MM)	12" (305 MM)	19 7/8" (505 MM)

**MITSUBISHI
WIRE
MACHINES**

DYNAMIC FILTRATION

DWC80
DWC100
DWC200



PART #	PART #	ID	OD	HEIGHT
5 MICRON	10 MICRON			
1014C-BH5	1014C-BH10	1 1/4" (32 MM)	10 1/4" (260 MM)	13 1/2" (343 MM)

DWC SB SERIES
DWC SZ SERIES
DWC SA SERIES

ALSO

FX SERIES
RA SERIES
QA SERIES





PART #	PART #	PART #	QUICK CONNECT	OD	HEIGHT
3 MICRON	5 MICRON	10 MICRON			
1220-3QC	1220-5QC	1220-10QC	COUPLER	12" (305 MM)	19 5/8" (498 MM)

**MITSUBISHI
WIRE
MACHINES**

DYNAMIC FILTRATION

CX
FX
RA
QA
FA
FX-K

TOP			BOTTOM		
					
PART #	PART #	PART #	QUICK CONNECT	OD	HEIGHT
3 MICRON	5 MICRON	10 MICRON			
1312-3QC	1312-5QC	1312-10QC	COUPLER	13 1/4" (337 MM)	12" (305 MM)

FX-K
FX
RA
QA
FA (some)

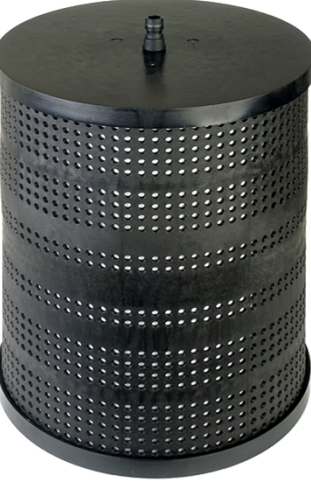
TOP			BOTTOM		
					
PART #	PART #	PART #	QUICK CONNECT	OD	HEIGHT
3 MICRON	5 MICRON	10 MICRON			
1316-3QC	1316-5QC	1316-10QC	COUPLER	13 1/4" (337 MM)	16 7/8" (428 MM)

**MITSUBISHI
WIRE
MACHINES**

DYNAMIC FILTRATION

FA10 SERIES
FA20 SERIES
FA30 SERIES
FA10 ADVANCE SERIES
FA20 ADVANCE SERIES
FA30 ADVANCE SERIES
NA1200 ADVANCE
MD PRO
MD PRO II
BA 24
MV SERIES
NA SERIES
MD1200R

TOP			BOTTOM		
PART #	PART #	PART #	QUICK CONNECT	OD	HEIGHT
3 MICRON	5 MICRON	10 MICRON			
1312-3QCM	1312-5QCM	1312-10QCM	COUPLER	13 1/4" (337 MM)	12" (305 MM)

**MITSUBISHI
WIRE
MACHINES**

FA10 SERIES
FA20 SERIES
FA30 SERIES
FA10 ADVANCE SERIES
FA20 ADVANCE SERIES
FA30 ADVANCE SERIES
NA1200 ADVANCE
MD PRO
MD PRO II
BA 24
MV SERIES
NA SERIES
MD1200R

**MAKINO
WIRE
MACHINES**

SP53 SERIES
SP64 SERIES
SP43 SERIES
EU SERIES
DUO43
DUO64
ECQ53

TOP		BOTTOM	
	COUPLERS IN CARTON		
FANUC		MITSUBISHI MAKINO	
PART #	QUICK CONNECT	OD	HEIGHT
3-5 MICRON			
DF1312-FM KIT	COUPLER	13 1/4" (337 MM)	12" (305 MM)

**FANUC
MACHINES**

IB SERIES
IE SERIES
OIC SERIES
OID SERIES

QC500
QC600
QC800

**MITSUBISHI
WIRE
MACHINES**

DYNAMIC FILTRATION

FX-K
FX
RA
QA
FA (some)

TOP



BOTTOM



COUPLER IN CARTON



PART #			QUICK CONNECT	OD	HEIGHT
3 - 5 MICRON					
DF1316-QC			COUPLER	13 1/4" (337 MM)	16 7/8" (428 MM)

**MITSUBISHI
WIRE
MACHINES**

CX
FX
RA
QA
FA
FX-K

TOP



BOTTOM



COUPLER IN CARTON



PART #			QUICK CONNECT	OD	HEIGHT
3 - 5 MICRON					
DF1312-QC			COUPLER	13 1/4" (337 MM)	12" (305 MM)

**MITSUBISHI
SINKER
MACHINES**

DYNAMIC FILTRATION

M25 SERIES
M SERIES
J SERIES
V SERIES



PART # 5 MICRON	PART # 10 MICRON	ID	OD	HEIGHT
1014-BH5	1014-BH10	1 1/4" (32 MM)	10 1/4" (260 MM)	13 1/2" (343 MM)

EA SERIES
VX SERIES
EX SERIES

TOP

BOTTOM



PART # 5 MICRON	QUICK CONNECT	OD	HEIGHT
1214-5QCL	COUPLER	12" (305 MM)	13 1/2" (343 MM)

**MITSUBISHI
SINKER
MACHINES**

DYNAMIC FILTRATION

VA10
EAV SERIES
EA-8
EA-D



PART #	QUICK CONNECT	ID	OD	HEIGHT
5 MICRON	OFFSET COUPLER	1 3/4" (44.5 MM)	12" (305 MM)	11 1/2" (292 MM)
1212-5QCL	COUPLER			

EAV-YM9
(ONLY ACCEPTS CENTER COUPLER)



PART #	QUICK CONNECT	ID	OD	HEIGHT
5 MICRON	CENTER COUPLER	1 3/4" (44.5 MM)	12" (305 MM)	11 1/2" (292 MM)
1212-5QCL-E	COUPLER			

**SODICK
WIRE
MACHINES**

DYNAMIC FILTRATION

A280L AP330
 A320 AP350
 A350 AP450
 A350S AW330
 A350W AW453
 A350SSW A5C
 A500 A6C
 A500W A7C
 A530 A10C
 A600 A15C
 A700 A5R
 AP200 AH5
 AP200L 40NC
 AP300 AQ750L

EPOC 300
 EPOC 500
 EPOC 600
 EPOC 800



1012-BH



1012-BHW

PART #	PART #	PART #	ID	OD	HEIGHT
5 MICRON	10 MICRON	20 MICRON			
1012-BH5	1012-BH10	1012-BH20	1 3/4" (44 MM)	10 1/4" (260 MM)	11 3/8" (289 MM)
1012-BHW5			1 3/4" (44 MM)	10 1/4" (260 MM)	11 3/8" (289 MM)

A300W AP500 SERIES
 A325 AP600 SERIES
 A350 A5300
 A350S AQ200L
 A350SS AQ300L
 A350SSW AQ325L
 A500 AQ327L
 A500W AQ400L
 A500WP AQ535L
 A600 AQ537L
 A600W AQ550
 A600WP AQ750L
 A750 AQ900L
 A750W AQ600 LH
 BF250 AQ750 LH
 BF275 VZ300L
 BF280

TOP



BOTTOM



PART #			ID	OD	HEIGHT
3 - 5 MICRON					
DF1312-BS			1 7/8" (48 MM)	13 1/4" (337 MM)	12 1/4" (311 MM)

**SODICK
WIRE
MACHINES**

DYNAMIC FILTRATION

A280	A500WP
A280L	A530D
A300W	A600
A320	A600W
A320D	A600WP
A325	A750
A350	A750W
A350W	A3200
A350S	A5300
A350SS	BF250
A350SSW	BF275
A500	BF280
A500W	AQ325L
	AQ535L

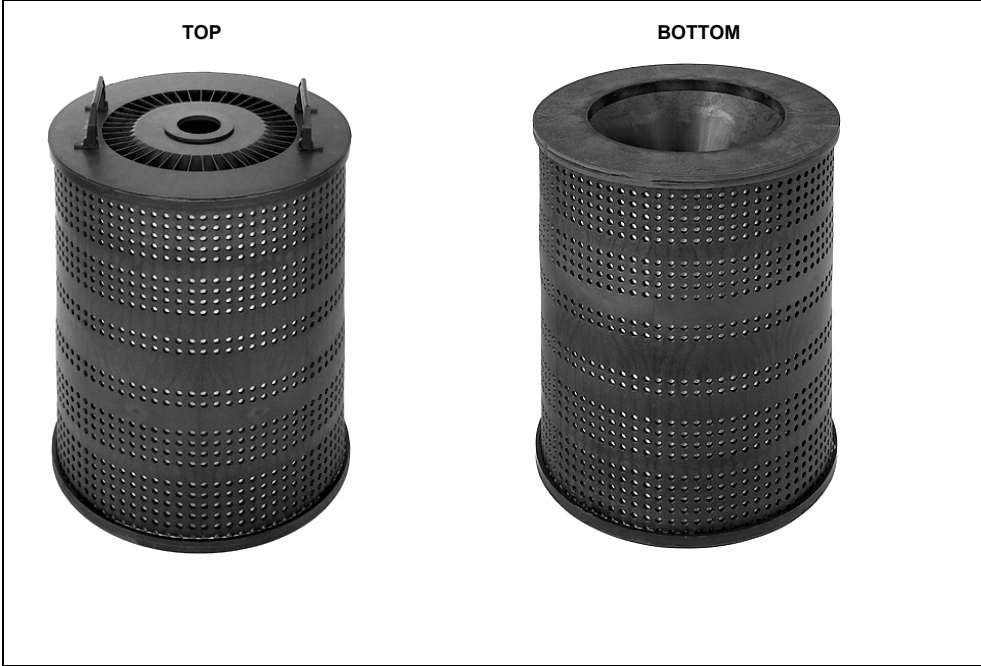

PART #	PART #	ID	OD	HEIGHT
5 MICRON	10 MICRON			
1318-B5S	1318-B10S	1 7/8" (48 MM)	13 1/4" (337 MM)	17" (432 MM)

A300W	AP500 SERIES
A325	AP600 SERIES
A350	A5300
A350S	AQ200L
A350SS	AQ300L
A350SSW	AQ325L
A500	AQ327L
A500W	AQ400L
A500WP	AQ535L
A600	AQ537L
A600W	AQ550
A600WP	AQ750L
A750	AQ900L
A750W	AQ600 LH
BF250	AQ750 LH
BF275	VZ300L
BF280	

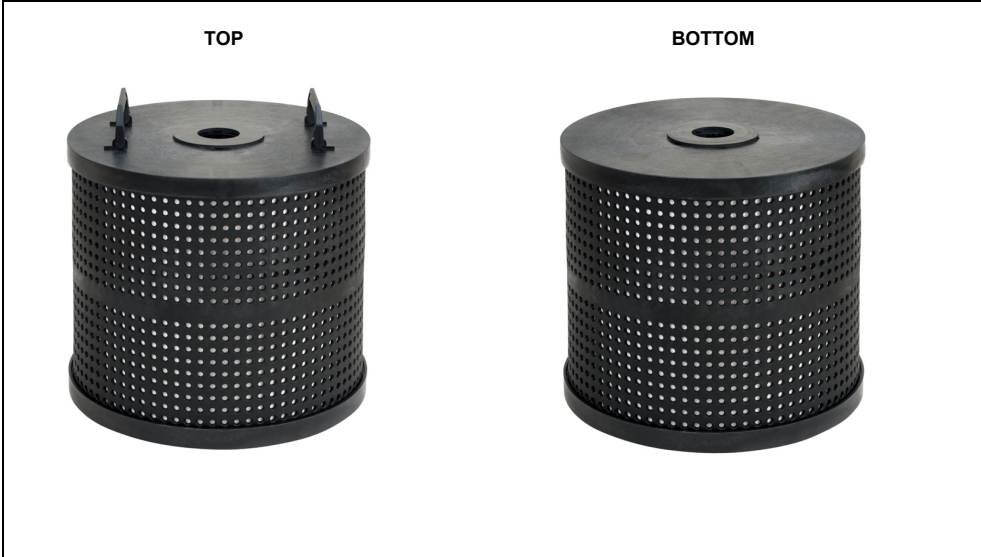

PART #	PART #	PART #	ID	OD	HEIGHT
3 MICRON	5 MICRON	10 MICRON			
1312-B3S	1312-B5S	1312-B10S	1 7/8" (48 MM)	13 1/4" (337 MM)	12 1/4" (311 MM)

**SODICK
SINKER
MACHINES**

DYNAMIC FILTRATION

A2	AP330
A3	AP330W
A4	AP453
A2C	AP453W
A3C	AP654W
A4C	EPOC2
A3R	EPOC3
A4R	APOC4
AP1	APOC6
AP3	22NC
AP3R	30NC
AP150	35NC
AP150W	W330A
AP200	W453
AP300	MM3 #8300 +
K1CN SERIES	MM5 #4074 +



718-125-B 718-125-BW 718-212-BHW 718-262-BH 718-262-BHW

PART # 5 MICRON	PART # 10 MICRON	PART # 20 MICRON	ID	OD	HEIGHT
718-125-B5			1 1/4" (32 MM)	6" (152 MM)	18" (457 MM)
718-125-BW5			1 1/4" (32 MM)	6" (152 MM)	18" (457 MM)
718-212-BHW5	718-212-BHW10	718-212-BHW20	2 1/8" (54 MM)	6" (152 MM)	18" (457 MM)
718-262-BH5	718-262-BH10	718-262-BH20	2 5/8" (67 MM)	6" (152 MM)	18" (457 MM)
718-262-BW5	718-262-BW10	718-262-BW20	2 5/8" (67 MM)	6" (152 MM)	18" (457 MM)
718-262-BHW5	718-262-BHW10	718-262-BHW20	2 5/8" (67 MM)	6" (152 MM)	18" (457 MM)

330W	GOW5
AW330	EPOC3W
453W	EPOC3WS
AW453	
654W	
G3A	
GOW3	



614-125-BH 614-125-BHW

PART # 5 MICRON	PART # 10 MICRON	PART # 20 MICRON	ID	OD	HEIGHT
614-125-BH5	614-125-BH10	614-125-BH20	1 1/4" (32 MM)	6" (152 MM)	14" (356 MM)
614-125-BHW5	614-125-BHW10	614-125-BHW20	1 1/4" (32 MM)	6" (152 MM)	14" (356 MM)

**SODICK
SINKER
MACHINES**

DYNAMIC FILTRATION

AD30L
 A30 AM55L
 A35 AW330
 A35R AW453
 A50 AQ35L
 A50R AQ55L
 A65 MM3
 A65R MM5
 A70 PGM3
 A85 PGM3R
 A85R PGM4
 A10C PGM4R
 AD3L PGM30
 AH7 PGM30R
 AH10 PGM50
 AH65 PGM50R
 AH85 PGM65
 AM3L PGM65R
 AM35L K1CN SERIES
 ALL AQ SERIES
 ALL AG SERIES



PART # 5 MICRON	PART # 10 MICRON	ID	OD	HEIGHT
1014-BH5	1014-BH10	1 1/4" (32 MM)	10 1/4" (260 MM)	13 1/2" (343 MM)

DYNAMIC FILTRATION

